

A new grid based wireless ad-hoc network testbed

D. Johnson, Y. Kaka, J. Hay
Meraka Institute, CSIR
djohnson@csir.co.za

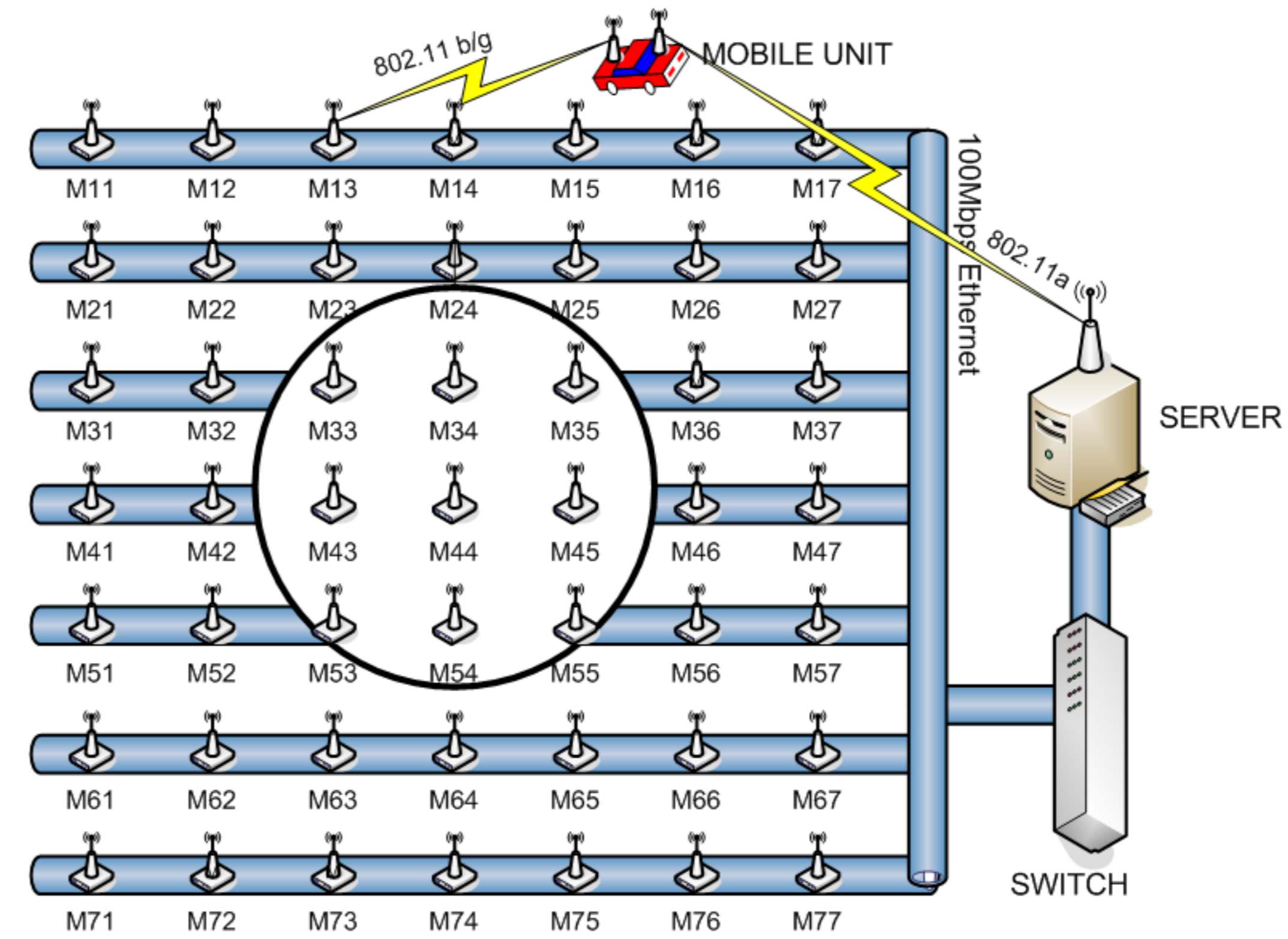
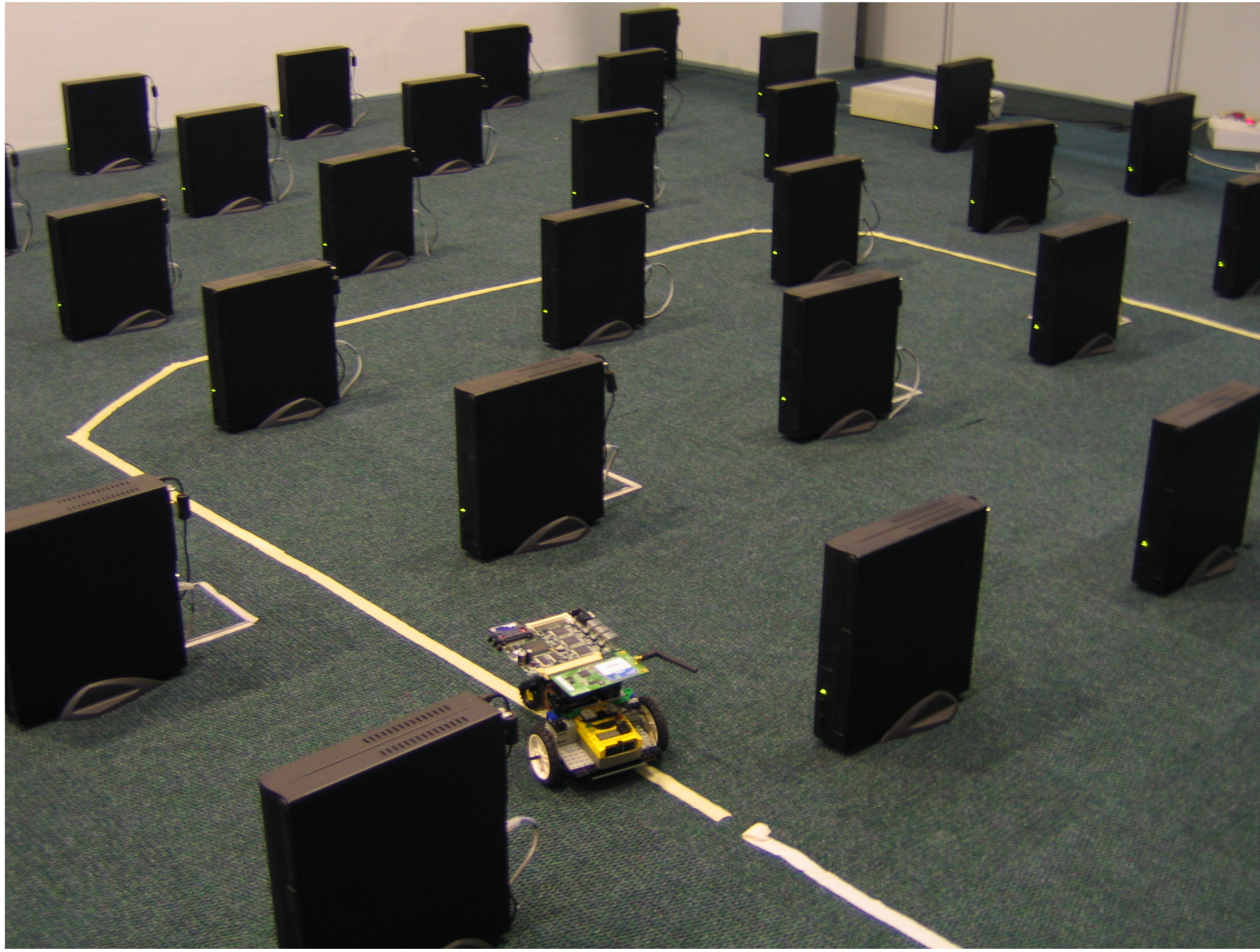

Figure 1: Wireless 7x7 grid design

Introduction

To profile the performance of an ad-hoc networking protocol, three possible methods can be applied. The first is to develop a mathematical model for the expected performance, the second is to run a series of computer simulations on the protocols and the third is to do analysis on a real test bed network which has implemented the ad-hoc networking protocol. This paper concerns the third option. Most researchers who have done work on test bed environments have used either indoor Wifi inter-office links or outdoor Wifi inter-residential links. This paper presents a new test bed environment which uses a grid of closely located Wifi enabled computers to carry out experiments

One of the key challenges for researchers in the field of wireless networking protocol design is to verify various performance metrics of their protocol. They will want to test features such as scalability, settling time after addition or removal of a node, delay over multiple hops and many other features.

Mathematical models are one of the tools to understand trends and effects of various network parameters on performance metrics such as BER vs. number of hops or maximum data rate vs. number of hops.

For example the famous equation below is used to understand the maximum possible data rate in a network versus the number of hops over a shared radio channel. [1] These sort of equations are useful for understanding trends but will not help when trying to benchmark protocols against each other.

$$\lambda(n) \in \Theta\left(\frac{W}{\sqrt{n \log(n)}}\right)$$

where W=data rate, n=number of hops

Simulations are another mechanism to test protocol performance but unfortunately omitting detail or oversimplifying the model can lead to ambiguous or erroneous results. There is also a lack of consistency between the results of same protocol being run on two different simulators [2]. The following table shows the results of a study done on 114 peer reviewed Manet research papers between 2000 and 2005 [2].

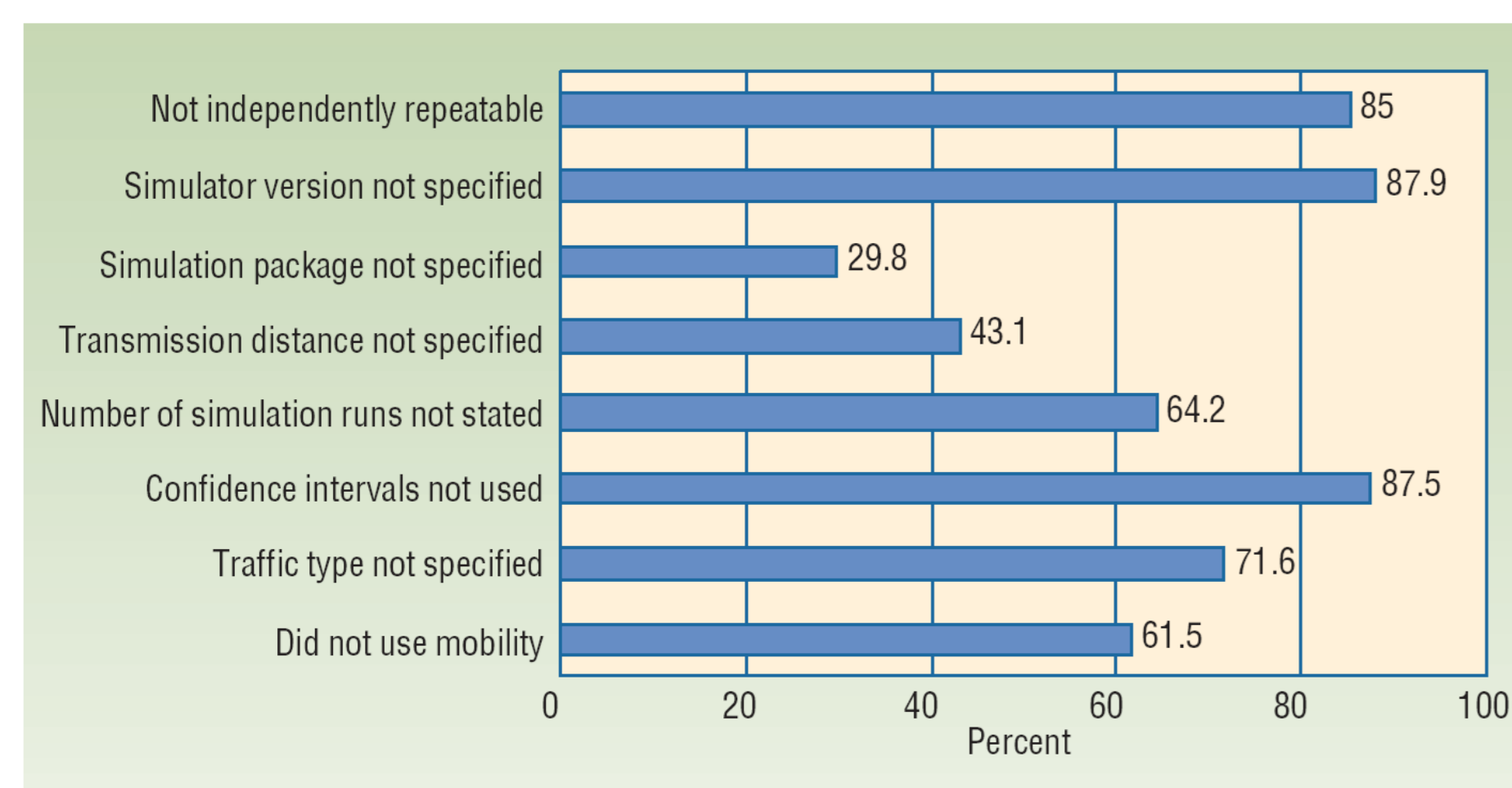

Table 1: Manet simulation issues

Construction of the 49 node wireless test bed

To overcome these challenges a large wireless 7x7 grid of 49 nodes was built within a large single room. A grid was chosen as the logical topology of the wireless test bed due to its ability to create a fully connected mesh network.

Every node was connected to a 100Mbit back haul Ethernet network through a switch to a central server which allowed the nodes to boot their operating and load their file system from the server using a combination of PXE booting and NFS. The robot used the 5.8GHz radio interface as a back haul channel for management and sending back measurement information.

To fit the nodes into a 7m wide room, meant that the grid spacing needed to be about 600mm. The first challenge was to find out if it was possible to locate the nodes in such close proximity of each other and create a multi-hop mesh.

Using a receive sensitivity of -74dBm, with the nodes locked at 54Mbps, a frequency of 2412MHz for channel 1 in 802.11b/g, a transmit power of 18dBm, a 2.15 dBi antenna gain for a rubber duck dipole and a distance of 600mm between nodes, it can be shown using the free space loss equation and a link budget equation that the required attenuation on each radio between the pigtail and antenna will need to be approximately 28dB.

Other factors to consider are the leakages from the Wifi card through the box housing the motherboard. Fortunately the box is made from metal which shields much of the RF leakage from the card and concentrates all transmitted power at the SMA connector at the end of the pigtail.

For the initial experiments, enough attenuation to create a single hop distance limitation was achieved simply by removing the antenna from the Wifi card due to the majority of power being reflected back to the card.

Results

A proactive routing protocol called OLSR [3] (Optimized Link State Routing) was loaded on the network using ETX (Expected Transmission Rate) as a path metric. ETX is the predicted number of data transmissions required to send a packet over that link, including retransmissions. A perfect single-hop link has an ETX of 1, with higher numbers indicating some packet loss.

The following figures show results where: all the nodes are fitted with external antennas, where only the middle node (M44) is fitted with and external antenna, where all the nodes have had their antennas removed and where M11 and M77 are fitted with external antennas. It is clear that the routing protocol is successfully building a optimal mesh based on signal quality.

In the network with no antennas, there is a surprising amount of non-uniformity in the resultant mesh network. Some nodes form many connected routes whereas some nodes don't even connect at all, this is due to variability in receive sensitivity and power levels of the Wifi cards. The ETX values at the edge of the mesh tend to be lower (better) than the ETX values in the centre of the mesh due to a larger hidden node problem in the centre with more packet collisions

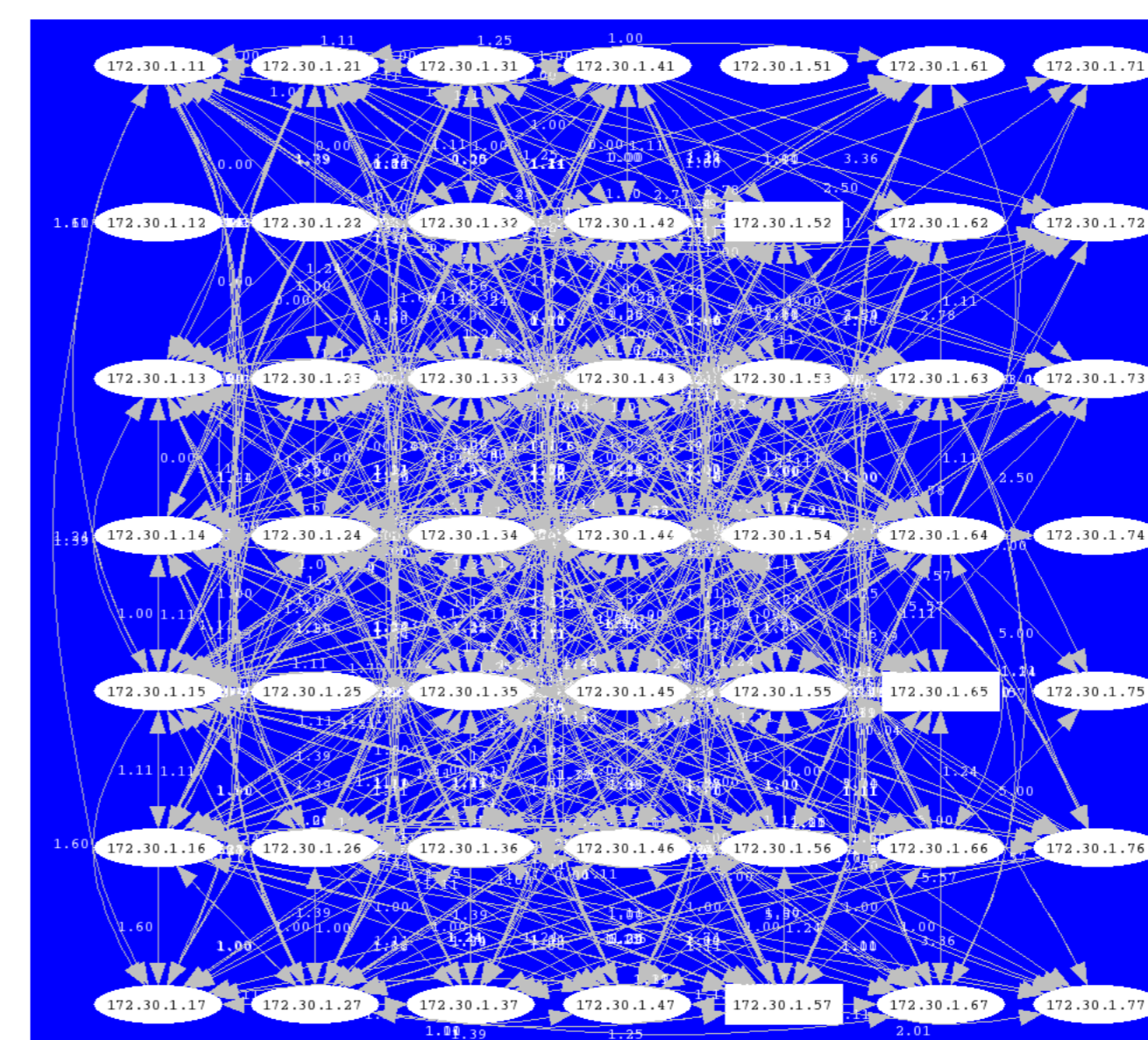

Figure2: All nodes with external antenna

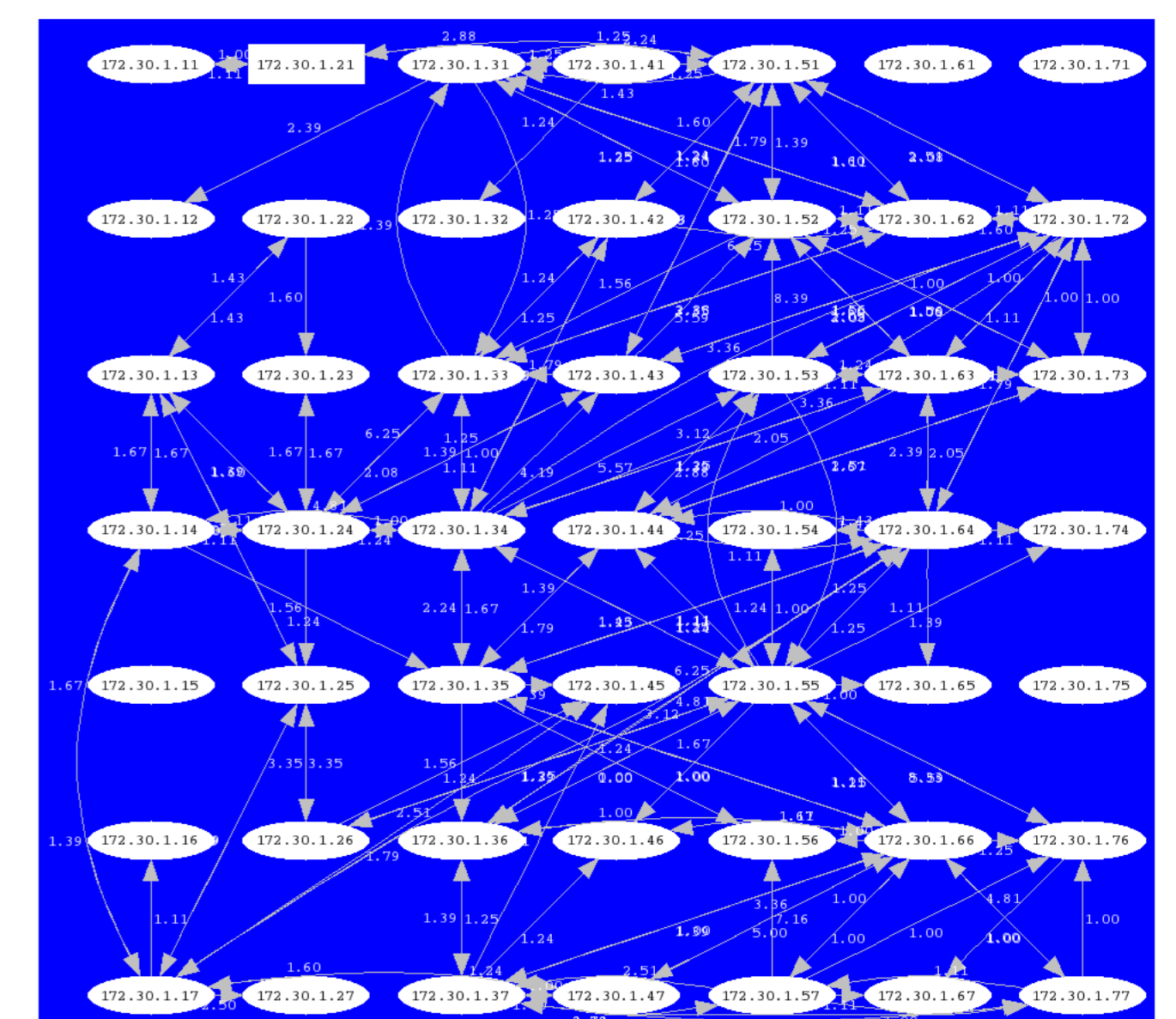

Figure3: All nodes with no antenna

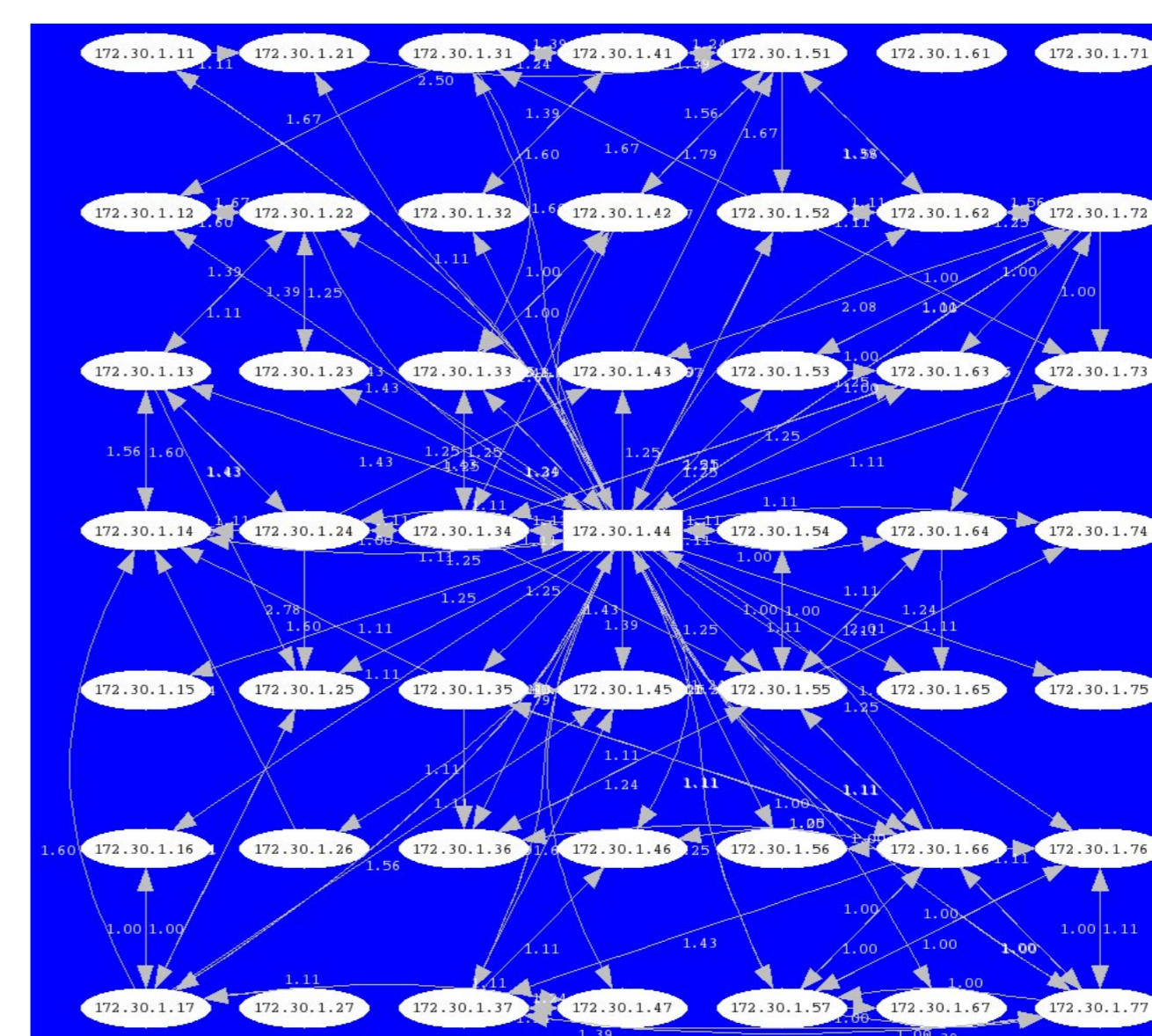

Figure 4: Node M44 has external antenna

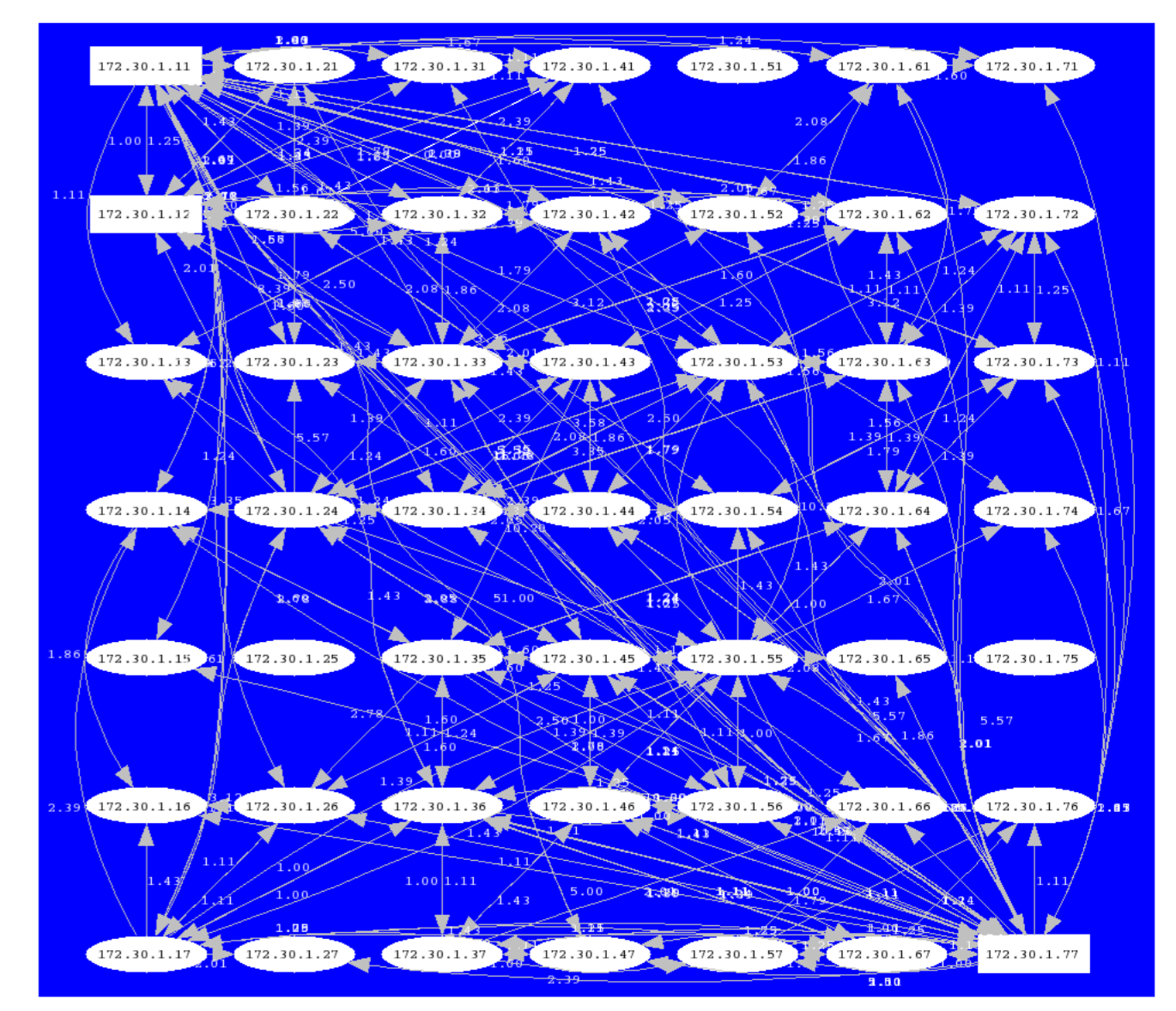

Figure 4: Node M11,M77 has external antenna

Conclusion

Judging by results so far, a close proximity grid network is a feasible method to benchmark and test ad-hoc routing protocols although a more scientific attenuation mechanism which is better than removing antennas is required. The multi-hop grid does create a worst case scenario mesh network which suffers from a large amount of hidden node problems and it is suspected that a vast Improvement will result if an improved MAC layer with a better scheduling algorithm than 802.11 DCF is run on the network. It is going to be interesting to see if optimal performance is achieved as the number of single hops approaches the magic number 6 as discussed by Lenard Kleinrock [4].

[1] P. Gupta and P. R. Kumar, "The capacity of wireless networks," IEEE Trans. Inf. Theory, vol. 46, no. 2, pp. 388-404, Mar. 2000
 [2] P. Jacquet, P. Muhlethaler, T. Clausen, A. Laouiti, A. Qayyum and L. Viennot, "Optimized link state routing protocol for ad hoc networks," in proc. IEEE INMIC - Technology for the 21st Century, pp. 62-68, Dec 2001
 [3] T. R. Andel, A. Yasinac, "On the Credibility of Manet Simulations", IEEE Computer Society, July 2006
 [4] L. Kleinrock, J. Silvester, Optimum transmission radii for packet radio networks or why six is a magic number, in: Proceedings of the IEEE National Telecommunications Conference, Birmingham, Alabama, December 1978, pp.4.3.1-4.3.5.